

1956

REVISED

COMPLETE COVERAGE

Amplifiers
Attenuators
Bolometer Mounts
Carrier Oscillators
Coaxial Instruments
Detectors
Directional Couplers
Distortion Analyzers
Electronic Counters
Electronic Tachometers
FM Monitors
Frequency Counters
Frequency Converters
Frequency Meters
Frequency Standards
Function Generators
Interpolation Oscillators
Low Pass Filters
Microwave Test Equipment
Nuclear Scalers
Oscillators
Oscilloscopes
Power Meters
Power Supplies
Pulse Generators
Signal Generators
Slotted Sections
Square Wave Generators
Standing Wave Indicators
Time Interval Meters
TV Monitors
Vacuum Tube Voltmeters
VHF Bridge
Video Test Oscillators
Waveform Analyzers
Waveguide Equipment



SHORT FORM CATALOG

HEWLETT-PACKARD COMPANY
275A Page Mill Road • Palo Alto, California, U.S.A.

-hp- Oscillators — .008 to 10,000,000 cps

-hp- 200 SERIES AUDIO OSCILLATORS



Four widely used *-hp-* oscillators have been redesigned into two compact, lightweight instruments offering wider frequency range, more operating simplicity, highest accuracy and stability. New Models 200AB and 200CD replace Models 200A through 200D, retain the time-tested RC circuits that insure constant output, low distortion; require no zero set. *-hp-* also offers Model 202A for sub-audio and audio tests; and Model 200J, a spread-scale oscillator for interpolation or where frequency must be known **precisely**.

-hp- 650A TEST OSCILLATOR

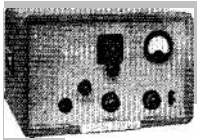

Highly stable, wide band (10 cps to 10 MC) multi-purpose test oscillator for audio, supersonic, video, and rf measurements. Output variable 30 μ v to 3 v. Frequency response flat \pm

1 db. Output impedance 600 ohms, or 6 ohms with voltage divider. \$490.00 Δ .

Instrument	Primary Uses	Frequency Range	Output	Price
-hp- 200AB	Audio tests	20 cps to 40 KC	1 watt/24.5 v	\$130.00
-hp- 200CD	Audio, ultrasonic tests	5 cps to 600 KC	160 mw/10 v *	160.00
-hp- 200J	Interpolation and frequency measurements	6 cps to 6 KC	160 mw/10 v *	275.00
-hp- 200T	Telemetry, carrier current tests	250 cps to 100 KC	160 mw/10 v *	350.00
-hp- 201C	High quality audio tests	20 cps to 20 KC	3 w/42.5 v	225.00
-hp- 202A	Low frequency measurements	.008 to 1,200 cps	20 mw/10 v	465.00 Δ
-hp- 202C	Low frequency measurements	1 cps to 100 KC	160 mw/10 v *	300.00
-hp- 205AG	High power tests, gain measurements	20 cps to 20 KC	5 watts	440.00 Δ
-hp- 206A	High quality, high accuracy audio tests	20 cps to 20 KC	+15 dbm	565.00 Δ
-hp- 233A	Carrier test oscillator	50 cps to 500 KC	3 w/600 ohms	475.00
-hp- 650A	Wide range video tests	10 cps to 10 MC	15 mw/3 v	490.00 Δ

*Open circuit 20 volts. Internal impedance 600 ohms.

-hp- Distortion, Wave Form Analyzers — 20 cps to 20 KC

-hp- 330B DISTORTION ANALYZER

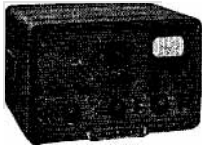

Measures distortion as low as 0.1%, 20 cps to 20 KC. Measures noise voltages as low as 100 μ v. High sensitivity, high stability, broad applicability for broadcast, laboratory or production.

Wide band 20 db gain input amplifier. Built-in VTVM usable separately. \$410.00 Δ .

Instrument	Primary Uses	Frequency Range	Characteristics	Price
-hp- 300A	Wave form analyzer	30 cps to 16 KC	Variable selectivity; measuring range 0.1 mv to 500 v	\$775.00
-hp- 330B	Measures total audio distortion	20 cps to 20 KC	Includes input amplifier, VTVM	410.00 Δ
-hp- 330C	For FM broadcast measurements	20 cps to 20 KC	Special VU meter to meet F.C.C. requirements	440.00 Δ
-hp- 330D	For AM-FM broadcast measurements	20 cps to 20 KC	AM detector and VU meter to meet F.C.C. requirements	455.00 Δ

-hp- Vacuum Tube Voltmeters — 10 to 700,000,000 cps

-hp- 400D VACUUM TUBE VOLTMETER



Best *-hp-* voltmeter ever built! Covers all frequencies 10 cps to 4 MC. Extremely sensitive, wide range, accurate within 2% to 1 MC, measures 0.1 mv to 300 v. Direct reading in dbm. 10 meg-ohm input impedance insures negligible loading on circuits under test. New amplifier circuit with 56 db mid-range feedback assures utmost stability, freedom from change due to external conditions. \$225.00.

Instrument	Primary Uses	Frequency Range	Voltage Range	Input Impedance	Price
-hp- 400AB	General purpose ac measurements	10 cps to 600 KC	0.3 mv to 300 v 11 ranges	10 megohms 15 μ mf shunt	\$200.00
-hp- 400D	Wide range ac measurements. High sensitivity	10 cps to 4 MC	0.1 mv to 300 v 12 ranges	10 megohms 15 μ mf shunt	225.00
-hp- 400H	Extreme accuracy measurements	10 cps to 4 MC	0.1 mv to 300 v 12 ranges	10 megohms 15 μ mf shunt	325.00
-hp- 410B	Audio, rf, VHF measurements; dc voltages; resistances	20 cps to 700 MC	0.1 to 300 v 7 ranges	10 megohms 1.5 μ mf shunt	245.00

-hp- Voltmeter Accessories (not listed) include voltage dividers, connectors, shunts and multipliers to extend the useful range of your equipment.

Δ Includes new lightweight all-metal cabinet with carrying handles. Also available for rack mounting at slightly lower prices.

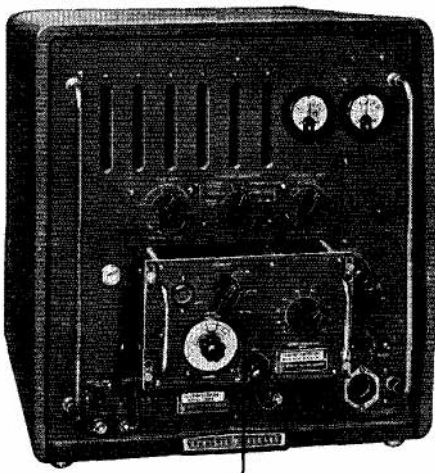

-hp- 524B COUNTER with -hp- 525A FREQUENCY CONVERTER

Frequency 10 cps to 220 MC, interval 1 μ sec to 100 days and period 0 cps to 10 KC—all measured instantly, automatically, directly by the revolutionary new *-hp- 524B* and its plug-in units. You buy just the instrumentation you need; later add inexpensive plug-ins to double, triple the versatility of this complete coverage instrument. For extended coverage to 12,000 MC, see *-hp- 540A* Transfer Oscillator below. *-hp- 524B* without plug-ins. \$2,150.00 Δ .

hp 524B ELECTRONIC COUNTER

with plug-in units to fit your exact measuring need

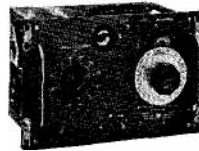

-hp- 525B Frequency Converter

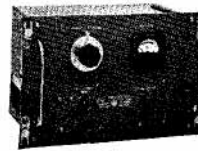

-hp- 526A Video Amplifier

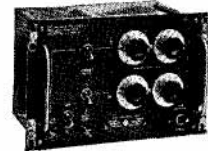

-hp- 526B Time Interval Unit

Instrument	Primary Uses	Frequency Range	Characteristics	Price
<i>-hp- 524B</i> Electronic Counter	Wide range highly accurate frequency, period measurements	0 cps to 10 MC	Without plug-in units measures frequency 10 cps to 10 MC, and period 0 cps to 0 KC, 1 volt rms minimum input	2,150.00 Δ
<i>-hp- 525A</i> Frequency Converter	Extends <i>-hp- 524B</i> range to 100 MC	0 cps to 100 MC	10 mv rms minimum input 10 MC to 100 MC 1.1 volt from 10 cps to 10 MC	150.00
<i>-hp- 525B</i> Frequency Converter	Extends <i>-hp- 524B</i> range 100 to 220 MC	00 MC to 220 MC	1.2 volt rms minimum input	250.00
<i>-hp- 526A</i> Video Amplifier	Increases sensitivity of <i>-hp- 524B</i>	10 cps to 10 MC	App. 10 millivolt rms minimum input	150.00
<i>-hp- 526B</i> Time Interval Unit	Used with <i>-hp- 524B</i> to measure time interval	Range: 1 μ sec to 10 ⁷ seconds Revolution: 0.1 μ sec	Start and stop channels separately adjustable for triggering from -192 v to +192 v	175.00

Other -hp- Frequency Measuring and Monitoring Equipment

-hp- 521A INDUSTRIAL COUNTER



Most useful, accurate, low cost industrial counter. Measures frequency, speed, rpm, random events, other phenomena. Direct readings 1 cps to 120 KC. Time of count 0.1 or 1.0 seconds; variable display time. High accuracy plug-in crystal controlled time base, \$100 extra. Sturdy, rugged, simple to operate. \$475.00.

-hp- 523B ELECTRONIC COUNTER

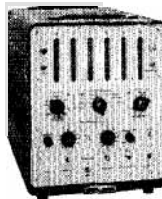

Revolutionary new all-purpose counter measures frequency 10 cps to 1.1 MC, time interval 3 μ sec to 27.8 hours, period 0.00001 cps to 10 KC. Stability 2/1,000,000 per week. Results displayed in sec, msec, μ sec or KC; automatic decimal. Display time variable 0.1 sec to 5 sec or indefinitely. Accuracy \pm 1 count plus crystal stability. 5 gate times, usable with 100 KC primary standard. \$1,175.00.

-hp- 522B ELECTRONIC COUNTER



Compact, low cost, versatile instrument for frequency, period or time measurements. Range 10 cps to 120 KC. Reads direct in cps, KC, seconds or milli-seconds. Count automatically reset, action repetitive. Stability of time base 5/1,000,000. Display length variable. Easily used by untrained personnel. \$915.00 Δ .

-hp- 540A TRANSFER OSCILLATOR



Extends frequency counter accuracy to microwave region. With *-hp- 524B* and *-hp- 525B* measures frequency of CW, pulse, or FM'd signals to 5,000 MC. With external detector extends range to 12,000 MC. \$615.00 Δ .

Instrument	Primary Uses	Frequency Range	Characteristics	Price
<i>-hp- 100D</i> Secondary Standard	Frequency, time measurements	100 KC, 10 KC, 1 KC, 100 cps, 10 cps	Stability 1/1,000,000 (short-time) Sine or rectangular output. Marker pips	\$ 615.00 Δ
<i>-hp- 335E</i> TV Monitor	TV visual, aural and % mod. monitor	Channels 2 through 83	Indicates visual, aural carrier frequency deviation, carrier separation, % modulation aural carrier	2,050.00
<i>-hp- 500B</i> Frequency Meter	Rapid frequency measurements	1 cps to 100 KC	7 ranges \pm 2% accuracy. Input 0.2 to 200 volts Provides expanded scale.	100.00
<i>-hp- 500C</i> Electronic Tachometer Indicator	Measurements of high speed machinery	100 to 3,000,000 rpm	7 ranges \pm 2% accuracy. Provides expanded scale.	285.00
<i>-hp- 506A</i> Optical Tach. Pickup	Phototube transducer	100 to 300,000 rpm	Utilizes reflected beam of light to permit measurement without loading	100.00
<i>-hp- 508A</i> Tachometer Generator	Low torque transducer	15 to 40,000 rpm	Provides 60 output pulses per rpm of rotating shaft	100.00
<i>-hp- 508B</i> Tachometer Generator	Low torque transducer	15 to 40,000 rpm	Provides 100 output pulses per rpm of rotating shaft	100.00
<i>-hp- 512A</i> Frequency Converter	Extends <i>-hp- 524A</i> range to 100 MC	100 KC to 100 MC	Fast, direct readings of signals to 100 MC with 524A. No charts, interpolation. Min. input 0.01 v	350.00
<i>-hp- 512B</i> Frequency Converter	Gives <i>-hp- 524A</i> range 100 to 220 MC	100 MC to 220 MC	Same as 512A except for frequency coverage and input 0.2 v RMS min.	350.00
<i>-hp- 520A</i> Nuclear Scaler	For counting high-rate pulses	Capacity 100 counts in 2 decades. 10,000,000 pps counting rate	100:1 divider for operation of low speed scalars	615.00 Δ
<i>-hp- 521A</i> Industrial Counter	Wide-range frequency, speed, measurements	1 cps to 120 KC	Gate time 1/10 or 1 second Input sensitivity control, 60 cycle time base. Crystal plug-in \$100.00	475.00
<i>-hp- 522B</i> Electronic Counter	Wide-range frequency, period, time interval measurements	10 cps to 120 KC	Measures rate of occurrences 0.00001 to 100,000 sec.; time interval 3 μ sec to 27.8 hrs.; periods of frequency count 1/1,000, 1/100, 1/10, 1, 10 sec.	915.00 Δ
<i>-hp- 523B</i> Electronic Counter	Wide-range frequency, period time interval measurements	10 cps to 1.1 MC	Measures rate of occurrences 0.00001 to 100,000 sec.; time interval 3 μ sec to 27.8 hrs.; periods of frequency counted 1 or 10 cycles of unknown.	1,175.00
<i>-hp- 540A</i> Transfer Oscillator	UHF, SHF frequency measurement	Fundamental frequency 100 MC to 220 MC	With 524B and 525B measures frequencies to 5,000 MC; with ext. detectors to 12 KMC	615.00 Δ

Δ Includes new lightweight all-metal cabinet with carrying handles. Also available for rack mounting at slightly lower prices. Data subject to change without notice. Prices f.o.b. factory.

Microwave Impedance Measuring Equipment



-hp- 415B STANDING WAVE INDICATOR

For all waveguide or coaxial slotted sections. Gives readings in SWR or db. Single frequency operation; 315 to 3,000 cps. Low noise level, 0.1 μ v (full scale) sensitivity, 60 db. calib. attenuator. \$200.00.



-hp- 416A RATIO METER

Automatically combines forward and reverse signals and displays their ratio directly, irrespective of amplitude variations. Contains rf power monitor indicating proper power level. Rear terminal signal available to operate oscilloscope or recorder. Suitable for single and swept frequency operation. \$450.00 Δ .

Instrument	Primary Uses	Frequency Range	Characteristics	Price
-hp- 360A-D Low Pass Filters	Eliminate harmonic voltages from UHF systems	Cutoff frequencies A-700 MC B-1,200 MC C-2,200 MC D-4,100 MC	50 db rejection at 1.25 cutoff freq.	\$ 40.00
-hp- 415B Standing Wave Indicator	SWR indicator or null indicator	315 to 3,000 cps Normal freq. 1,000 cps	0 to 60 db. attn. Max. sensitivity 0.1 μ v full scale	200.00
-hp- 416A Ratio Meter	Measures reflection coefficient, SWR	1,000 cps \pm 40 cps	Min. 3 millivolts and 0.3 μ v; accuracy \pm 2%	450.00 Δ
-hp- 417A VHF Detector	VHF bridge detector (for -hp- 808A)	10 to 500 MC	Approx. 5 μ v sensitivity	250.00
-hp- 803A VHF Bridge	Measurement of VHF impedance, SWR	50 to 500 MC	2 to 2,000 ohms impedance — 90° to + 90° phase angle	495.00
-hp- 805A Coaxial Slotted Section	Measurement of SWR	500 to 4,000 MC	For Type N Connectors, flexible cables	475.00
-hp- 805B Coaxial Slotted Section	Same as above	Same as above	For rigid 7/8" RG44/U line	475.00
-hp- 806B Coaxial Slotted Section	Same as above (Mounts in 809B)	3,800 to 12,000 MC	For Type N Connectors, flexible cables	200.00
-hp- 809B Universal Probe Carriage	Supports 806B section, also G, J, H, X and P810B Waveguide sections		Accepts 442B and 444A probes	160.00

-hp- Waveguide Test Equipment — 2.6 to 40.0 KMC

Basic, low-cost elements offer utmost flexibility for assembly of exact instrumentation required. Each unit covers entire range of its waveguide size. Simple, sturdy mechanical design; accurate, multi-purpose operation.

Instrument	Coaxial Type N Conn.	"S"	"G"	"J"	"H"	"X"	"P"	"K"	"R"
		3" x 1 1/2" 2.6 - 3.95 KMC	2" x 1" 3.95 - 5.85 KMC	1 1/2" x 3/4" 5.2 - 8.2 KMC	1 1/4" x 3/4" 7.05 - 10.0 KMC	1" x 1/2" 8.2 - 12.4 KMC	7/2" x 3/4" 12.4 - 18.0 KMC	5/2" x 25/16" 18.0 - 26.5 KMC	3/2" x 22/16" 26.5 - 40.0 KMC
Adapter, Waveguide to Coax		S281A \$50	G281A \$40	J281A \$35	H281A \$30	X281A \$25			
Cover to choke flange		S290A \$65	G290A \$50	J290A \$35	H290A \$25	X290A \$15	P290A \$20		
Attenuators, Fixed 3, 6, 10, 20 db		S370A \$75	G370A \$65	J370A \$65	H370A \$60	X370A \$55	P370A \$60		
Flap, 25 db max.		S375A \$120	G375A \$110	J375A \$100	H375A \$90	X375A \$85	P375A \$80	K375A \$60	R375A \$70
Calibrated, precision		S380A \$260	G382A \$500	J382A \$350	H382A \$350	X382A \$250	P382A \$275		
Detector Mounts	420A \$50	S485D* \$145	G485D \$140	J485D* \$135		X421A \$75	P421A \$85		
	440A† \$85	S485A† \$125	G485B† \$95	J485B† \$90	H485B† \$85	X485B† \$75	P485C‡ \$110		
Isolators						X365A \$225			
Thermistor Mounts (Fixed tuned) ■	477B \$75		G487B \$95	J487B \$90	H487B \$80	X487B \$75		K487B \$85	
Frequency Meters, Reaction				J530A/B**	H530A \$120	X530A \$120	P530A \$150		
Waveguide						X532A \$125			
Directional Couplers, Cross Guide: 20, 30 db		S750 \$130	G750 \$120	J750 \$70	H750 \$60	X750 \$50			
Directional Couplers, Multi Hole: 3, 10, 20 db		S752 \$375	G752 \$250	J752 \$140	H752 \$120	X752 \$75	P752 \$100	K752 \$100	R752 \$120
Universal Waveguide Carriage		809B for frequencies 3,000 to 18,000 MC \$160							
Slotted Sections, Waveguide		S810A* \$460	G810B§ \$110	J810B§ \$110	H810B§ \$110	X810B§ \$90	P810B§ \$110		
Universal Probe Carriage								B14 for frequencies 12.4 to 40.0 KMC \$225	
Slotted Sections, Waveguide								P815A \$200	K815A \$200
Transformers, Slide Screw		S870A \$225	G870A \$185	J870A \$150	H870A \$130	X870A \$125	P870A \$130	K870A \$140	R870A \$140
E-H						X880A \$130	P880A \$135	K880A \$155	R880A \$170
Waveguide Phase Shifter				J885A \$400		X885A \$300	P885A \$350		
Waveguide Horn						X890A \$30	P890A \$30		
Terminations, Low Power		S910A \$45	G910A \$35	J910A \$30	H910A \$25	X910A \$20	P910A \$25	K910A \$30	R910A \$35
Terminations, High Power		S912A \$160				X912A \$50			
Moving Load		S914A \$100	G914A \$75	J914A \$70	H914A \$60	X914A \$50	P914A \$55	K914A \$65	R914A \$75
Standard Reflections						X916A \$100			
Adjustable Shorts		S920A \$90	G920A \$70	J920A \$60	H920A \$50	X920A \$40	P920A \$55	K920A \$75	R920A \$85
Broad Band Probe	442B \$35	All frequencies							
Broad Band Probe, Untuned		444A \$35 2.6 to 12.4-KMC				446A \$145 12.4 to 40 KMC			

†For use with barretter or crystal.

‡For use with barretter only.

*Complete assembly including carriage.

§Mounts in 809B Carriage—See next page.

■ Includes Thermistor, installed. See page 5.

**J530A, 5.85 to 8.2 KMC, \$120; J530B, 5.30 to 7.05 KMC, \$150.

* Includes barretter; checked for square law characteristics.

Δ Includes new lightweight all-metal cabinet with carrying handles. Also available for rack mounting at slightly lower prices.

Microwave Power Measuring Equipment

-hp- 430C MICROWAVE POWER METER



No computations! Provides instantaneous, automatic power readings *direct* in dbm or mw at all frequencies for which there are suitable bolometer mounts. For CW measurements, uses either 1/100 amp. fuse or Sperry 821 barretter. Also measures CW or pulsed power with negative coefficient thermistor. Provides up to 16 ma bias current. Operates with all mounts in adjacent table. \$250.00.

ma bias current. Operates with all mounts in adjacent table. \$250.00.

-hp- 764D-767D DUAL DIRECTIONAL COUPLERS



New high directivity dual coaxial couplers make reflectometer measurements practical in vhf and uhf coax systems. Flat response, high power capacity, low insertion loss. Four models, covering 216 to 4,000 MC collectively. \$125.00.

-hp- 477B COAXIAL THERMISTOR MOUNT



For frequency range 10 MC to 10 KMC. SWR less than 1.5. Thermistor element is 200 ohm negative. \$75.00 (including thermistor).

Instrument	Primary Uses	Frequency Range	Characteristics	Price
-hp- 430C Microwave Power Meter	Measurement of rf power	Depends on Bolometer mount	.01 to 10 mw \pm 5% accuracy	\$250.00
-hp- 475B Tunable Bolometer Mount	Measurement of rf power	1,000 to 4,000 MC	Matches 50 ohm line to 100 or 200 ohms	200.00
-hp- 476A Universal Bolometer Mount	Measurement of rf power	10 to 1,000 MC	No tuning required SWR less than 1.25	85.00
-hp- 477B Coaxial Thermistor Mount	Measurement of rf power	10 to 10,000 MC	Broad band, low SWR, no tuning	75.00
-hp- 485 Waveguide Detector Mount	Measurement of rf power	4,000 to 18,000 MC	Full coverage of waveguide band	See Table page 4
-hp- 487A Waveguide Thermistor Mount	Measurement of rf power	4,000 to 12,000 MC	Full coverage, no tuning, 1.5 SWR	See Table page 4
-hp- 764D Dual Directional Coupler	Reflectometer and rf power measurements	216 to 450 MC	Coupling attenuation* 20 db, directivity 30 db	125.00
-hp- 765D Dual Directional Coupler	Reflectometer and rf power measurements	450 to 940 MC	Coupling attenuation* 20 db, directivity 30 db	125.00
-hp- 766D Dual Directional Coupler	Reflectometer and rf power measurements	940 to 1,975 MC	Coupling attenuation* 20 db, directivity 26 db	125.00
-hp- 767D Dual Directional Coupler	Reflectometer and rf power measurements	1,900 to 4,000 MC	Coupling attenuation* 20 db, directivity 26 db	125.00

*Power handling capacity all 764/767 series couplers 50 watts CW, 10 Kw peak.

Equipment below available for most waveguide frequencies

See table at left for data, prices.

-hp- 809B UNIVERSAL PROBE CARRIAGE

-hp- 810 WAVEGUIDE SLOTTED SECTIONS

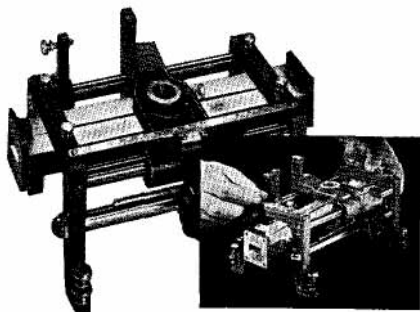

Convenient, all-purpose -hp- 809B carriage operates with six different -hp- slotted sections, waveguide and coaxial. Mounts sections covering frequencies 3,000 to 18,000 MC—sections *interchange in 30 seconds!* Precision-built carriage calibrated in mm to 0.1 mm; dial gauge may be mounted. Operates with -hp- 442B Broad Band Probe and -hp- 440A Coaxial Detector in combination; or with -hp- 444A Untuned Probe.

-hp- 810A/B Slotted Sections. -hp- 810B, for mounting in 809B carriage, is a flanged waveguide section with accurately machined slot tapered at ends to minimize reflection. Available in 5 waveguide bands, 3.95 thru 18.0 KMC. -hp- S810A, complete slotted section assembly including probe carriage. Available for 2.6 to 3.95 KMC band only.

-hp- 420A/B CRYSTAL DETECTORS



Employs a silicon crystal to detect rf signals in Type N coaxial line. Covers frequencies 10 MC to 12.5 KMC. Model 420B, for reflectometer measurements, \$75.00. 420A, \$50.00. Uses modified 1N26 crystal.

-hp- 382A PRECISION ATTENUATOR



Precision broad band attenuation to 50 db. Completely independent of frequency; phase shift constant all attenuations. Calibrated range 0 to 50 db, maximum error \pm 2% of db reading. G, J, H, X and P bands available covering 3,950 to 18,000 MC. SWR less than 1.15 full range.

-hp- 281A WAVEGUIDE - COAX ADAPTERS



For convenient transition between waveguide and coax systems. Each unit covers a full waveguide range with SWR less than 1.25. Equipped with Type N connectors.

-hp- 444A UNTUNED PROBE



A 1N26 crystal plus small antenna in a convenient, easy-to-use housing. Variable penetration depth, no tuning required. Sensitivity equal to single- or double-tuned probes. Frequency range: 2.6 to 18.0 KMC. Mounts in 809B Carriage.

-hp- 487A THERMISTOR MOUNT

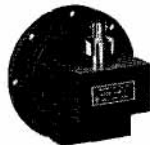

For fast, accurate waveguide power measurements. Each mount covers full range of its waveguide frequency. No tuning required, SWR less than 1.5. Rugged construction, high temperature coefficient permanent thermistors virtually eliminate delays due to detector element burn-out.

-hp- 885A PHASE SHIFTER

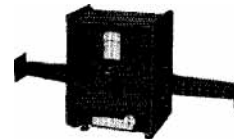

For accurate, precisely controlled phase variation throughout frequency band. Ideal for microwave impedance, transmission measurements, antenna and system design. Direct reading, low power absorption, 360° (electrical) range.

-hp- 752 MULTI-HOLE COUPLER



Directional couplers available in 2 models with coupling factors of 3, 10 and 20 db \pm 0.7 db over full range of a waveguide. SWR better than 1.05. Directivity 40 db or better over entire range. Available as a 3-terminal equal power splitting network.

-hp- 485B DETECTOR MOUNTS



To measure power over complete waveguide range in conjunction with -hp- 430C Power Meter and barretter. Also measures relative level, or detects rf energy using 1N21 or 1N23 crystal. Semi-tuned by movable short to SWR 1.25.

-hp- X532A FREQUENCY METER

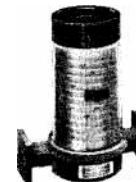

Inexpensive, general-purpose, direct-reading. Consists of high Q resonant cavity tuned by choke plunger; no sliding contacts. Full range coverage 8.2 to 12.4 KMC, accuracy 0.08%, resettability 0.01%. 1.5 db output dip indicates resonance. No backlash. \$125.00.

Δ Includes new lightweight all-metal cabinet with carrying handles. Also available for rack mounting at slightly lower prices.

Data subject to change without notice. Prices f.o.b. factory.

-hp- Signal Generators — 10 to 21,000 MC

-hp- 608D vhf SIGNAL GENERATOR

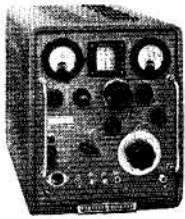

10 to 420 MC. Highest stability. No incidental FM or frequency drift. Calibrated output 0.1 μ v to 0.5 v throughout range. Built-in crystal calibrator provides frequency check accurate within 0.01% each 5 MC. Master-oscillator, intermediate and output amplifier circuit design. Premium quality performance, direct calibration, ideal for aircraft communications equipment testing. \$1,050.00.

-hp- 608C vhf Signal Generator. High power (1 v max.) stable, accurate generator for lab or field use. 10 to 480 MC. Ideal for testing receivers, amplifiers, driving bridges, slotted lines, antennas, etc. \$950.00.

-hp- 626/628A shf SIGNAL GENERATORS

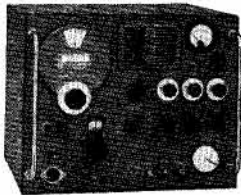

New instruments, bringing high power, wide range, convenience and accuracy to 10 to 21 KMC range. Frequencies, output voltage directly set and read. Output 10 to 20 db better than previous spot-frequency sets. SWR better than 1.2 at 0 dbm and

lower. Internal pulse, FM or square wave modulation; also external pulsing or FM'ing. **-hp- 626A**, 10 to 15.5 KMC, \$3,250.00. **-hp- 628A**, 15 to 21 KMC, \$3,000.00.

-hp- 212A PULSE GENERATOR

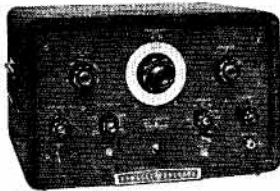

Provides continuously variable, high power "fast pulses" of superior wave form. Combines broad general usefulness with 0.02 μ sec rise and decay time to meet requirements

of radar, TV and nuclear work. Pulse length variable 0.07 to 10 μ sec; minimum overshoot; 50 watt peak power (50 v to 50 ohms load). Low impedance means accurate pulses can be delivered at a distance from the instrument. Repetition rate variable 50 to 5,000 pps; controlled internally or externally. Synchronizing pulses available in advance of, or following output pulse. \$565.00 Δ .

Instrument	Frequency Range	Characteristics	Price
-hp- 608C	10 to 480 MC	Output 0.1 μ v to 1 v into 50 ohm load. Pulse or CW modulation. Direct calibration.	\$ 950.00
-hp- 608D	10 to 420 MC	Output 0.1 μ v to 0.5 v into 50 ohm load. Pulse or CW modulation. Direct calibration and crystal calibrator check	1,050.00
-hp- 612A	450 to 1,220 MC	Output 0.1 μ v to 0.5 v into 50 ohm load. Pulse, CW or amplitude modulation to 5 MC Direct calibration.	1,200.00
-hp- 614A	800 to 2,100 MC	Output 0.1 μ v to 0.223 v into 50 ohm load. Pulse, CW or FM modulation. Direct calibration.	1,950.00
-hp- 616A	1,800 to 4,000 MC	Output 0.1 μ v to 0.223 v into 50 ohm load. Pulse, CW or FM modulation. Direct calibration.	1,950.00
-hp- 618B	3,800 to 7,600 MC	Output 0.1 μ v to 0.223 v into 50 ohm load. Pulse, CW, FM or square wave modulation. Direct calibration.	2,250.00
-hp- 620A	7,000 to 11,000 MC	Output 0.1 μ v to 0.223 v into 50 ohm load. Pulse, CW, FM or square wave modulation. Direct calibration.	2,250.00
-hp- 623B	5,925 to 7,725 MC (in three bands)	Output 70 μ v to 0.223 v into 50 ohm load. FM or square wave modulation. Separate power meter and wave meter section.	1,750.00
-hp- 624C	8,500 to 10,000 MC	Output 3.0 μ v to 0.223 v into 50 ohm load. Pulse, FM or square wave modulation. Separate power meter and wave meter section.	2,265.00 Δ
-hp- 626A	10,000 to 15,500 MC	Output 1 μ watt to 10 mw. Internal or external pulse, FM, or square wave modulation. Direct calibration.	3,250.00
-hp- 628A	15,000 to 21,000 MC	Output 1 μ watt to 10 mw. Internal or external pulse, FM, or square wave modulation. Direct calibration.	3,000.00

SWEPT FREQUENCY OSCILLATORS

-hp- 670SM	2,600 to 4,000 MC	Output app. 10 mw entire frequency range. Automatic, adjustable, mechanical sweep.	1,175.00
-hp- 670GM	4,000 to 6,000 MC	Output app. 10 mw entire frequency range. Automatic, adjustable, mechanical sweep.	1,175.00
-hp- 670JM	5,850 to 8,200 MC	Output app. 10 mw entire frequency range. Automatic, adjustable, mechanical sweep.	1,175.00
-hp- 670HM	7,000 to 10,000 MC	Output app. 10 mw entire frequency range. Automatic, adjustable, mechanical sweep.	1,175.00

SQUARE WAVE AND PULSE GENERATORS

-hp- 211A Square Wave Generator	1 cps to 1 MC	Output 55 v peak to peak into 600 ohm load. Free running or external sync. .02 μ sec rise time. Low or high impedance output.	265.00
-hp- 212A Pulse Generator	50 to 5,000 pps	Output 50 v peak into 50 ohm load. Free running or external sync. Variable delay. .02 μ sec rise time	565.00 Δ

-hp- Regulated Power Supplies

-hp- 715A POWER SUPPLY



-hp- 715A is a versatile source of regulated beam and reflector voltage for operating most test bench klystron tubes. Beam voltage 250 to 400 v; reflector voltage 0 to 900 v; 6.3 v filament. Internal, 1,000 cps square wave modulation, also 60 cps FM modulation, both on reflector voltage. \$300.00.

-hp- 712B POWER SUPPLY

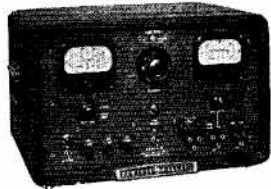

This new **-hp-** instrument features high regulation of 0.01%, 0.1 millisecond transient response, internal impedance 0.1 ohms in series with 25 μ H; full-load maximum hum less than 500 μ v, sealed transformers, chokes and condensers. 0 to 500 v, 200 ma supply and fixed —300 v tap providing a 50 ma, 300 to 800 v variable supply for klystron operation. \$365.00 Δ .

Instrument	Primary Uses	Characteristics	Price
-hp- 710B Power Supply	For low power bench and permanent setups	100 to 360 volts at 75 milliamperes	100.00
-hp- 711A Power Supply	For powering experimental bench setups requiring wide voltage range, low power	0 to 500 volts at 100 milliamperes	225.00
-hp- 712B Power Supply	Meets requirements for heavy duty field and lab work	0 to 500 volts at 200 milliamperes 0.01% regulation	365.00 Δ
-hp- 715A Klystron Power Supply	Regulated beam, reflector source for low power klystrons	Beam 250 to 400 volts at 50 milliamperes. Reflector 0-900 volts	300.00
-hp- 717A Klystron Power Supply	Regulated beam, reflector source for Type 5721 klystrons and for -hp- 670 series Swept Frequency Oscillators	800 to 1,000 volts at 25 milliamperes	375.00

Δ Includes new lightweight all-metal cabinet with carrying handles. Also available for rack mounting at slightly lower prices.

Data subject to change without notice. Prices f.o.b. factory.

Amplifiers for General Use and Fast-Circuit Work

-hp- TRAVELING-WAVE TUBE AMPLIFIERS

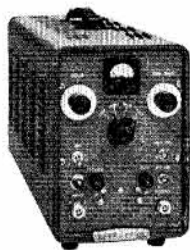

Now -hp- offers Traveling-Wave Tube Amplifiers for all frequencies 2 to 12.4 KMC. -hp- 490B, 2 to 4 KMC, supersedes -hp- 490A and is similar except for 30 db gain and helix modulation provision. -hp- 491, also 2 to 4 KMC, has higher output of 1 watt. -hp- 492A and 494A are low level, high

gain amplifiers with 30 and 25 db gain; they offer amplitude, pulse, phase or FM modulation. All amplifiers have exclusive -hp- helical coupling system, and employ encapsulated traveling-wave tubes that can be readily replaced. -hp- 490B/491A, \$1,100.00. -hp- 492A/494A, \$1,500.00.

-hp- 460A/B FAST PULSE AMPLIFIERS



-hp- 460A Wide Band Amplifiers, in cascade with -hp- 460B Fast Pulse Amplifiers, provide up to 90 db gain, 125 v open circuit. This permits full deflection of 5XP CRT, or 2" deflection of 5CP tubes. Rise time 0.0026 μ sec. Will amplify millimicrosecond pulses. Over 100 MC band width for scopes. -hp- 460A, \$185.00. -hp- 460B, \$225.00.

Instrument	Primary Uses	Frequency Range	Characteristics	Price
-hp- 450A Amplifier	General purpose lab amplifier	5 to 1,000,000 cps	20 and 40 db gain, freq. response $\pm 1/2$ db	\$ 140.00
-hp- 460A Amplifier	Wide band, pulse amplification	100 KC to 140 MC	20 db gain, rise time 0.0026 μ sec.	185.00
-hp- 460B Amplifier	Pulse amplification, high output	100 KC to 140 MC	15 db gain, 125 peak volts	225.00
-hp- 490B Travelling-Wave Tube Amplifier	Amplification and pulse modulation	S-Band—2 to 4 KMC	High gain, low noise, broad band 30 db gain	1,100.00
-hp- 491A Travelling-Wave Tube Amplifier	Power gain to 1 watt	S-Band—2 to 4 KMC	30 db gain, can be pulse modulated	1,100.00
-hp- 492A Travelling-Wave Tube Amplifier	AM, FM, pulse, phase modulation	4 KMC to 8 KMC	Low level, high gain, 30 db gain	1,500.00
-hp- 494A Travelling-Wave Tube Amplifier	AM, FM, pulse, phase modulation	7 KMC to 12.4 KMC	Low level, high gain, 25 db gain	1,500.00

-hp- Low Frequency, High Frequency Oscilloscopes

A completely new design philosophy enables these new instruments to set revolutionary standards for oscilloscope usefulness, convenience and long-term dependability.

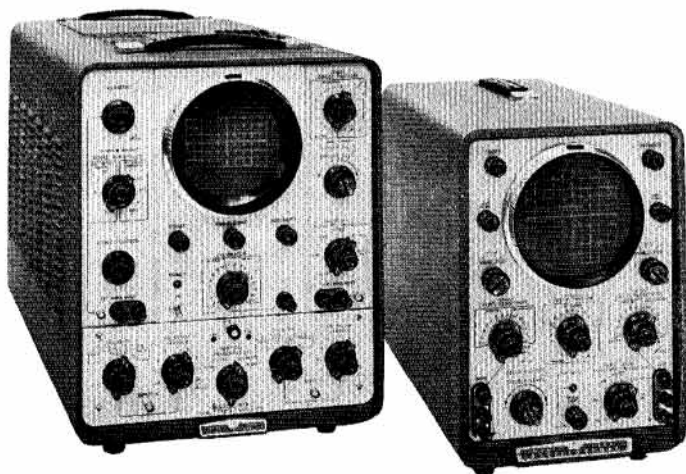

Both instruments have universal automatic triggering where one preset adjustment provides optimum triggering for all conditions. Other features include unitized circuits, etched, mounted on "see-through" plastic; highest quality components, ultra conservative design; concentric color-coded controls, direct sweep-time selection.

-hp- 130A Low Frequency Oscilloscope has 1 mv/cm sensitivity, dc to 300 KC, sweeps 1 μ sec/cm to 15 sec/cm, may be triggered by internal source, line voltage or external sources 2 v or more. 21 calibrated ranges, direct reading. Similar vertical, horizontal amplifiers, input attenuator; 14 ranges, continuous vernier. Amplitude calibration 1 KC square wave, 5% accuracy. \$450.00.

-hp- 150A High Frequency Oscilloscope, dc to 10 MC, has plug-in pre-amplifiers offering either high gain or dual trace. Model 150A sweeps 0.02 μ sec/cm to 15 sec/cm. 24 calibrated sweep ranges, direct reading. Triggered internally, line voltage, or externally. Horizontal amplifier with magnification feature expanding horizontal sweep 5, 10, 50 or 100 times. Vertical amplifier rise time less than 0.035 μ sec; signal delay line permits leading edge of triggering signal to be seen. Amplitude calibrator 18 1 KC square wave voltages, accuracy 3%. Supplied separately are: -hp- 151A High Gain Amplifier, \$100.00 and -hp- 152A Dual Channel Amplifier, \$200.00. -hp- 150A Oscilloscope (without plug-in amplifiers), \$1,000.00.

Cabinet, End Frame, Or Rack Mounting

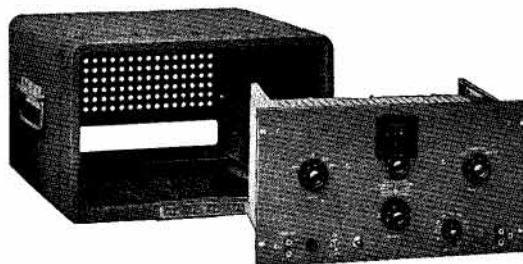

To give you greatest flexibility in your setup, -hp- equipment having the standard 19" panel can be mounted in the new, streamlined all metal cabinets; with end frames; or in standard relay racks. -hp- AC-44 aluminum-and-steel cabinets are attractive, sturdy, easily removable, equipped with carrying handles. With instrument, \$15.00. Separate \$25.00.

Smaller -hp- Instruments, too, are now being delivered in new-streamlined cabinets. This rugged, lightweight metal cabinet is now offered with such instruments as -hp- 200AB, 200CD, 410B and 715A.

Many -hp- instruments are basically rack mounting and can be installed directly in 19" racks. Other instruments can be equipped for relay rack mounting at slight additional charge. Write for details.



complete coverage

In electronic test instruments, Hewlett-Packard gives you complete coverage several different ways.

In development — *-hp-* engineer teams are continually at work designing and producing accurate, helpful new instruments that meet and anticipate the demands of electronics.

In instrumentation — the *-hp-* line is the world's largest and most complete. You choose from over 250 instruments the ones that provide exactly the measuring coverage you require.

In frequency coverage — *-hp-* makes nearly every kind of useful electronic test instrument. And, for almost all

useful frequencies, too. For example, *-hp-* signal generators offer solid frequency coverage from 10 to 21,000 MC; *-hp-* voltmeters from 2 to 700,000,000 cps, oscillators from .008 to 10,000,000 cps.

In personal service — *-hp-* has selected the best independent organizations to give you personal help with measuring problems. Electronic specialists—men trained by Hewlett-Packard—save you time by helping select the exact *-hp-* instrumentation you need — and following through to be sure the equipment is properly utilized to serve you best. These men are located in major business centers—as near as your telephone. Call them when you need personal help,—in your plant, today.

Albuquerque, New Mexico
Neely Enterprises
107 Washington St. S. E.
Albuquerque 5-5586

Asbury Park, New Jersey
I. E. Robinson Company
702 Mattison Avenue
DUnkirk 9-2404

Atlanta 5, Georgia
Bivins & Caldwell
3133 Maple Drive, N. E.
CHerokee 7522

Bogota, New Jersey
R. M. C. Associates
114 East Main Street
DLamond 2-5343

Bridgeport 8, Connecticut
Yewell Associates, Inc.
1101 East Main Street
FOrrest 6-3456

Camp Hill, Pennsylvania
I. E. Robinson Company
2120 Market Street
REgent 7-5541

Chicago 40, Illinois
Alfred Crossley Associates, Inc.
4501 North Ravenswood Ave.
UPtown 8-1141

Cleveland 21, Ohio
S. Sterling Company
4311 Mayfield Road
EVergreen 2-4114

Dallas 9, Texas
Earl Lipscomb Associates
P. O. Box 7084
ELmhurst 5345

Dayton 9, Ohio
Alfred Crossley Associates, Inc.
53 Park Avenue
OXmoor 3594

Denver 3, Colorado
Hytronic Measurements Associates
446 Broadway
SHerman 4-2241

Detroit 35, Michigan
S. Sterling Company
15310 West McNichols Rd.
BRoadway 3-2900

Fort Myers, Florida
Arthur Lynch & Associates
P. O. Box 466
Edison 4-4431

High Point, North Carolina
Bivins & Caldwell
Security Bank Building
High Point 3672

Houston 5, Texas
Earl Lipscomb Associates
P. O. Box 6573
JACKson 4-9303

Kansas City 30, Missouri
Harris-Hanson Company
7916 Paseo Blvd.
Hiland 4-6744

Las Cruces, New Mexico
Neely Enterprises
126 S. Water Street
JACKson 6-2486

Los Angeles, California
Neely Enterprises
3939 Lankershim Blvd.
North Hollywood, Calif.
STanley 7-0721

New York 21, New York
R. M. C. Associates
236 East 75th Street
TRafalgar 9-2023

Phoenix, Arizona
Neely Enterprises
641 East Missouri
CRestwood 4-5431

Pittsburgh 22, Pennsylvania
S. Sterling Company
355 Fifth Avenue
ATLantic 1-9248

Portland 9, Oregon
ARVA (formerly Ron Merritt Co.)
1238 N. W. Glisan
CApitol 7-1281

Sacramento 14, California
Neely Enterprises
1317 - 15th Street
GILbert 2-8901

San Diego 6, California
Neely Enterprises
1029 Rosecrans Street
ACademy 3-8106

San Francisco 18, California
Neely Enterprises
2830 Geary Blvd.
WALnut 1-2361

Seattle 99, Washington
ARVA (formerly Ron Merritt Co.)
120 West Thomas Street
GARfield 6644

St. Louis 17, Missouri
Harris-Hanson Company
2814 South Brentwood Boulevard
MISsion 7-4350

St. Paul 14, Minnesota
Alfred Crossley Associates, Inc.
842 Raymond Avenue
MIDway 5-4955

Syracuse 2, New York
J. D. Ryerson Associates, Inc.
412 East Genesee St.
SYracuse 76-8344

Toronto 10, Ontario, Canada
Atlas Radio Corporation, Ltd.
50 Wingold Avenue
RUssell 1-6174

Upper Darby, Pennsylvania
I. E. Robinson Company
7404 West Chester Pike
SHerwood 8-1294

Waltham 54, Massachusetts
Yewell Associates, Inc.
751 Main Street
TWINbrook 3-7420

Washington 9, D. C.
Horman Associates, Inc.
2017 S Street, N. W.
DEcatur 2-5705

Winnipeg, Manitoba
Atlas Radio Corporation, Ltd.
505 McIntyre Building



HEWLETT-PACKARD COMPANY

275A PAGE MILL ROAD • PALO ALTO, CALIFORNIA, U.S.A.
CABLE "HEWPACK"